



LET'S BUILD A BETTER FUTURE

 Modern **PARTITIONING SYSTEMS**

# MB-HARMONY



INTERIOR GLASS  
PARTITION SYSTEM  
**MB-HARMONY**

# MB-HARMONY

## INTERIOR GLASS PARTITION SYSTEM

Tempered, laminated and acoustic glass from 10 to 12 mm

The structurally light profiles are only 31 mm high

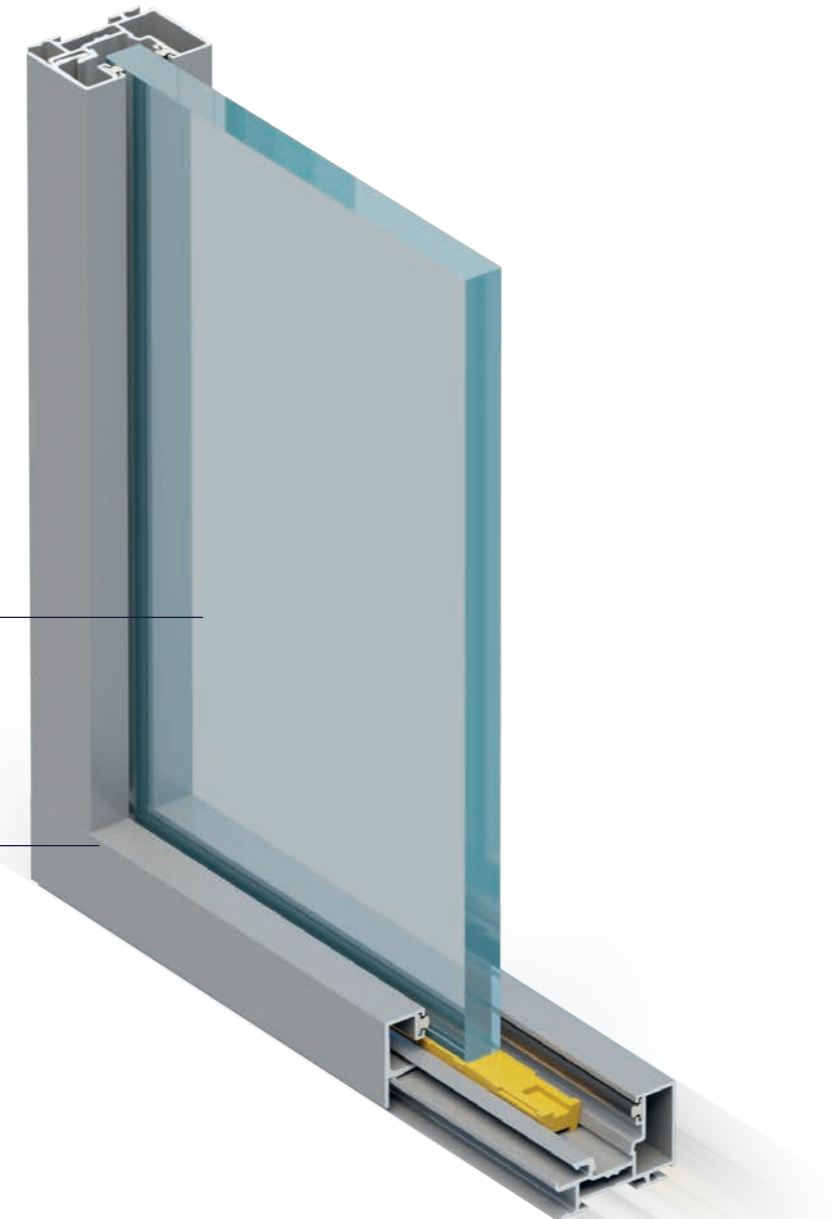

The MB-HARMONY is a single-glazed system which is part of the MB-HARMONY OFFICE glass partition series. Geometrically light and easy to assemble, it requires no special construction tools. It is designed to be combined with tempered glass or with 10-12 mm acoustic glass. The system is ideal for typical office spaces, even those with acoustic requirements above the norms.

Our MB-HARMONY OFFICE is a new range of products for the construction of interior glass partitions. It was conceived to create an easily prefabricated and quickly installed system that delivers durable, contemporary and spacious designs with guaranteed performance and user comfort.

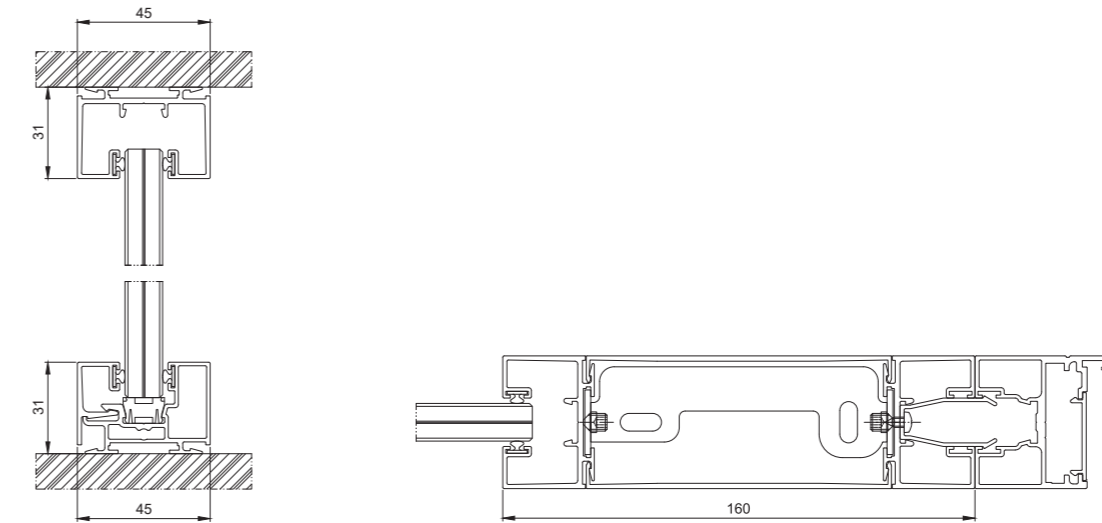
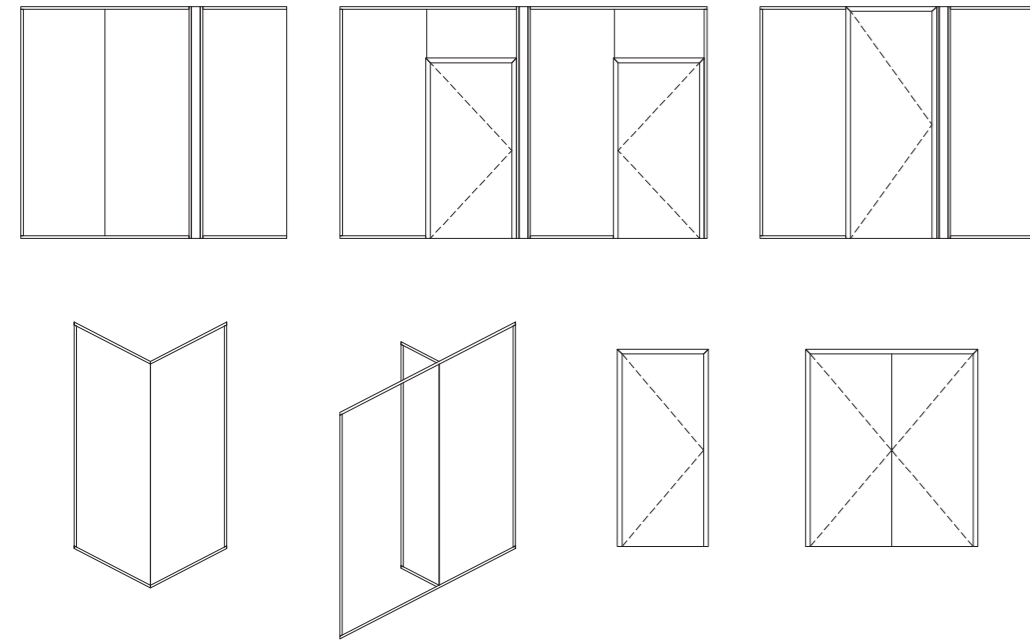

Internal partition, vertical cross-section

Horizontal cross-section through the mullion and door frame

SPECIFICATIONS	MB-HARMONY OFFICE
Glazing	ESG 10, ESG12, VSG 55.1, VSG 55.2, VSG 66.1, VSG 66.2 VSG 55.2 with acoustic foil, VSG 66.2 with acoustic foil
Acoustic insulation	R <sub>w</sub> of 39 dB max. / RA1 of 38 dB max.
Use category	IVb
Room category	A, B, C1+C5, D
Height	3200 / 3600 mm*
Finishing	anodised, RAL colours, ADEC wood and concrete colours

\* for glass types ESG 12, VSG 66.1, VSG 66.2 and VSG 66.2 with acoustic film

## FEATURES AND BENEFITS

- the structurally light profiles are only 31 mm high
- the entire system consists of just a few basic elements
- the connectors and accessories have been reduced to a minimum
- the system is simple to prefabricate and to install, that can be done on site
- the unique installation panel is built using base profiles
- acrylic joints by walls are unnecessary
- hardware and accessories are mainly installed without machining, which has been limited to no more than a few instances
- the required machining can be carried out using portable tools
- the concealed glazing gaskets are inserted before the profiles are installed
- the stability and reliability of the structure has been confirmed by tests
- the universal frame is suitable for all types of doors



# MB-HARMONY DUO



INTERIOR GLASS  
PARTITION SYSTEM  
**MB-HARMONY DUO**

# MB-HARMONY DUO

INTERIOR GLASS PARTITION  
SYSTEM

High sound insulation in office spaces to 48 dB

The structurally light profiles are only 31 mm high

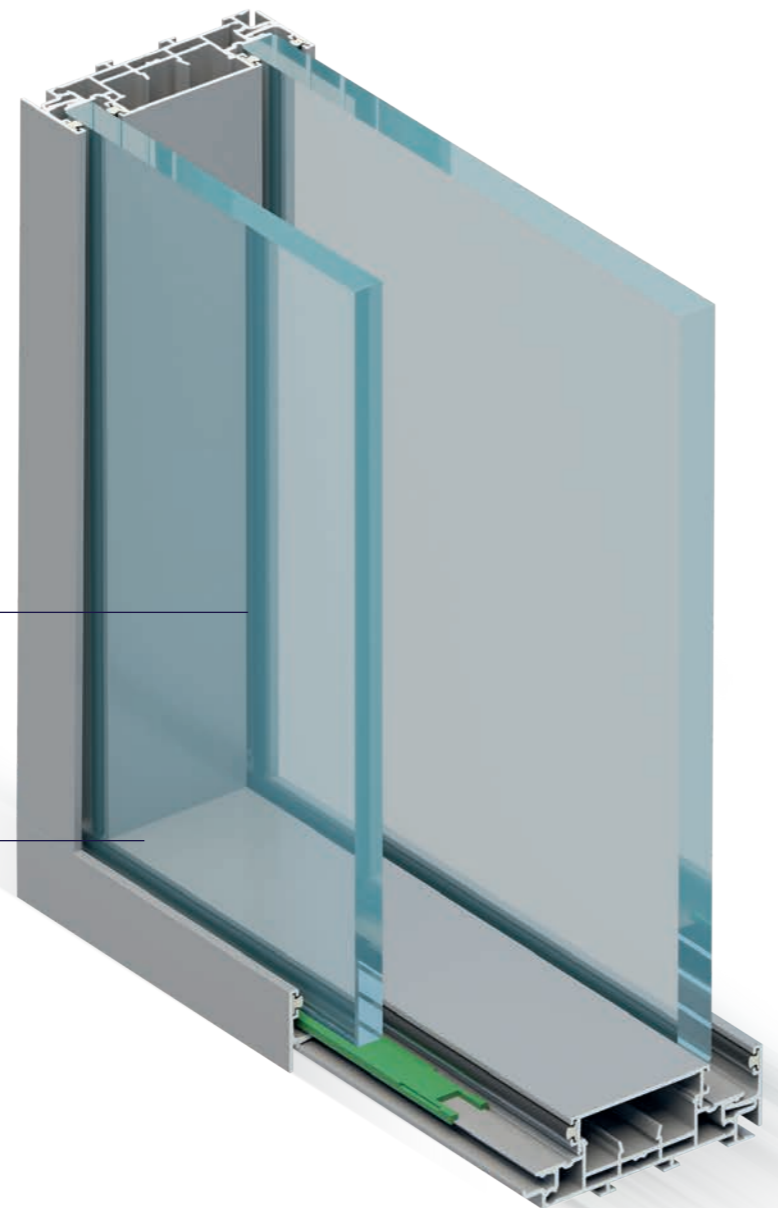

INTERIOR GLASS PARTITION SYSTEM / **MB-HARMONY DUO**

The MB-HARMONY DUO is a system for building double-glazed interior partitions. It was designed primarily for office spaces with very high acoustic requirements. The double glazing provides the insulation essential to maintain both excellent user comfort and the privacy of conversations held inside.

The DUO echoes the geometry of single-glazed partitions of its sister system, the MB-HARMONY, meaning that both solutions can be used together to create an aesthetic consistency.

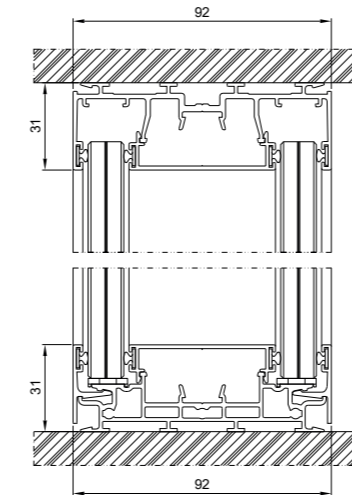
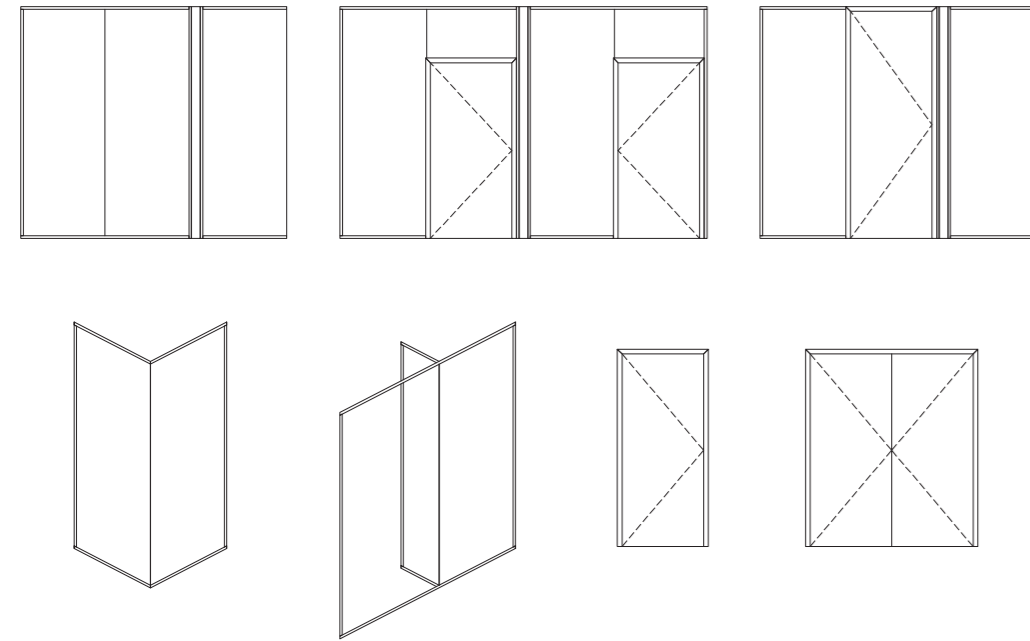

Internal partition, vertical cross-section

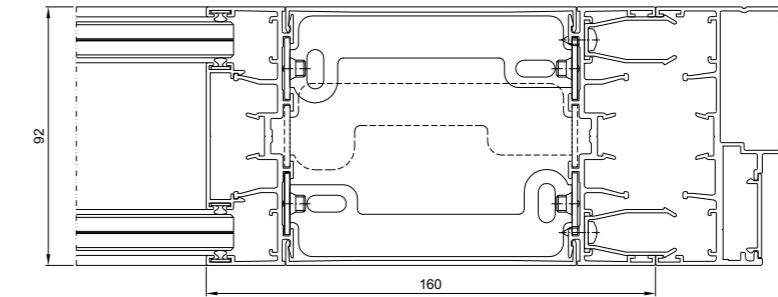

Horizontal cross-section through the mullion and door frame

SPECIFICATIONS	MB-HARMONY DUO
Glazing	ESG 10, ESG12, VSG 55.1, VSG 55.2, VSG 66.1, VSG 66.2 VSG 55.2 with acoustic foil, VSG 66.2 with acoustic foil
Acoustic insulation	$R_w$ of 48 dB max. / $RA1$ of 46 dB max.
Use category	IVb
Room category	A, B, C1+C5, D
Height	3200/3600 mm*
Finishing	anodised, RAL colours, ADEC wood and concrete colours

\* for glass types VSG 66.1, VSG 66.2, VSG 66.2 and VSG 66.2 with acoustic film, ESG 12 mm

## FEATURES AND BENEFITS

- the structurally light profiles are only 31 mm high
- the MB-HARMONY and MB-HARMONY DUO solutions are compatible
- the entire system consists of just a few basic elements
- the connectors and accessories have been reduced to a minimum
- the system is simple to prefabricate and to install, that can be done on site
- the unique installation panel is built using base profiles
- acrylic joints by walls are unnecessary
- hardware and accessories are mainly installed without machining, which has been limited to no more than a few instances
- the required machining can be carried out using portable tools
- the stability and reliability of the structure has been confirmed by tests
- the universal frame is suitable for all types of doors
- the concealed glazing gaskets are inserted before the profiles are installed



# MB-EXPO MB-EXPO MOBILE



PARTITION WALLING  
SYSTEMS  
**MB-EXPO**  
**MB-EXPO MOBILE**



# MB-EXPO MB-EXPO MOBILE

## PARTITIONING SYSTEM

Tempered glass panes 8, 10, and 12 mm

Two groups of profiles of different heights: 36 mm and 100 mm



**MB-EXPO** system is an elegant, glass partition walling system designed for various types of internal partition walls with all-glass doors, whose function is to separate and to soundproof the selected areas, without visually limiting the space as it is the case with non-transparent walls.

**MB-EXPO MOBILE** is an internal walling system that enables fabrication of high-quality segment doors such as accordion and folding doors. The possibility of using MB-EXPO MOBILE in high ceilings areas (about 4 m high) and of having a wide, openable door, makes it a solution oriented mainly towards shops, shopping malls, exhibition centres and office buildings.

**MB-EXPO & MB-EXPO MOBILE** profiles are fitted to enable installation of the hardware (locks, hinges, suspension brackets, parked systems) manufactured by Aluprof and Geze. Panes are structural component of both systems and the glazing gaskets remain invisible, whichever the side. Both systems are offered in a variety of colours, and allow easy fabrication & installation.

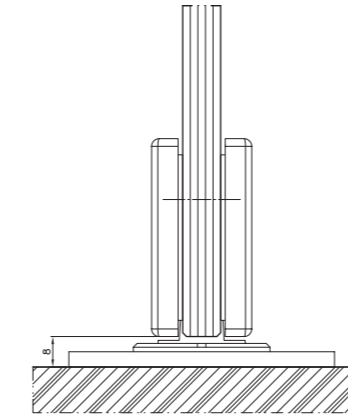
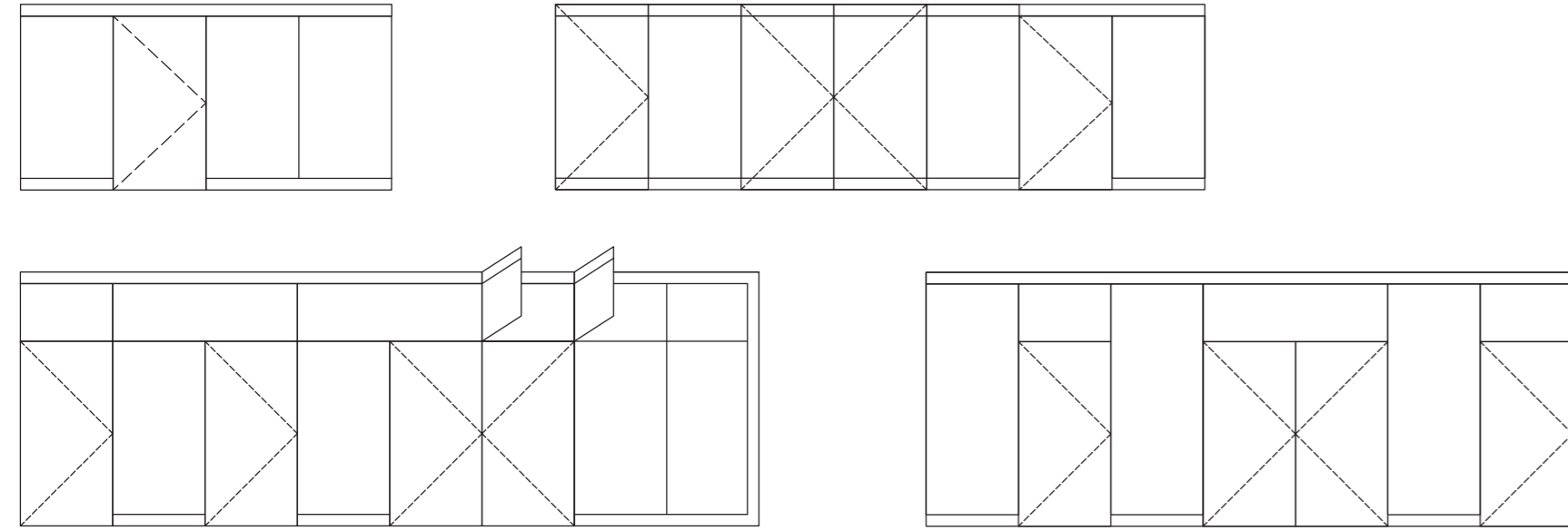

All-glass door leaf – lower view

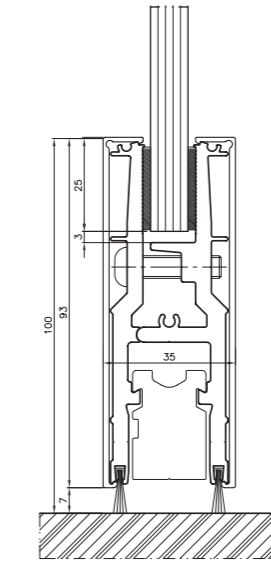

Mobile and door leaf – lower cross section

MB-EXPO MOBILE SELECTED CONFIGURATIONS

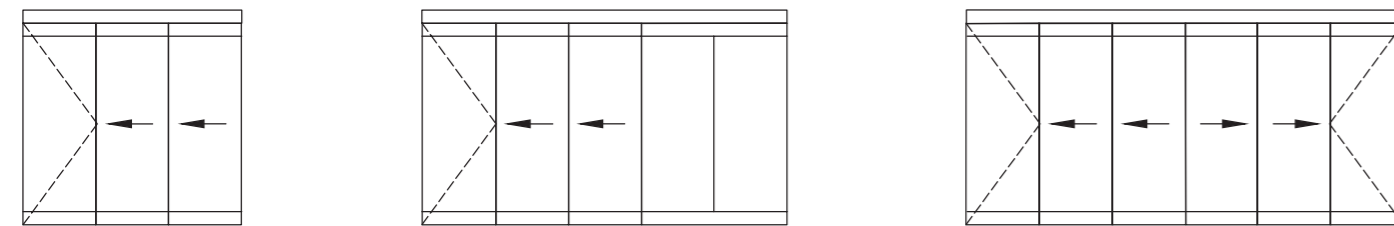

FEATURES AND BENEFITS

- invisible glazing gaskets
- light and elegant structure
- glazing 8, 10 and 12 mm
- fixed profile depth regardless of the glass pane thickness
- structures up to 4 m high
- adapted to use numerous companies' hardware products: Aluprof, Geze



# MB-80 OFFICE



PARTITION WALLING  
SYSTEMS  
**MB-80 OFFICE**

# MB-80 OFFICE

## PARTITION WALLING SYSTEMS

Excellent sound insulation in office spaces – noise reduction of 50 dB, depending on the type of infill

Different types of infill:  
glass panes, furniture boards,  
gypsum plasterboards

Integrated partitions with  
electrical fittings



This internal partition double-glass walling system is designed to fabricate internal partitions in offices and other public facilities.

The system enables the use of different types of infills, transparent or obscure, with internal louvers and electrical components and office equipment. These walls are especially suitable in buildings where a high sound insulation is required.

The basic feature of this construction is its versatility in arranging office space, combined with the simplicity of execution of all the works on site.



## MB-80 OFFICE SELECTED CONFIGURATIONS

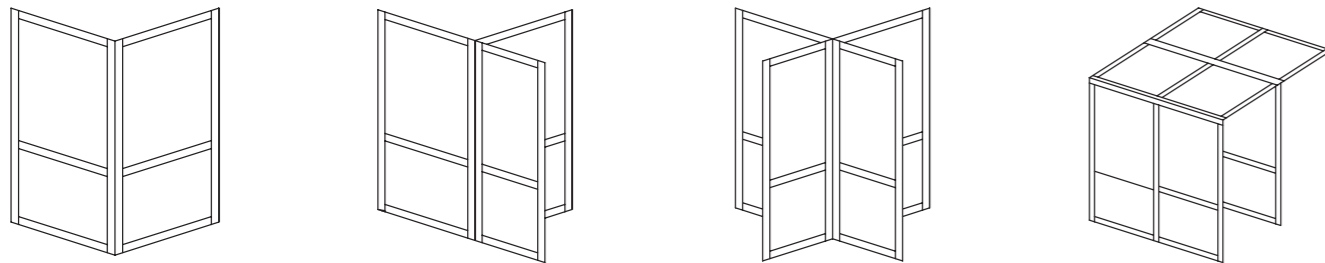
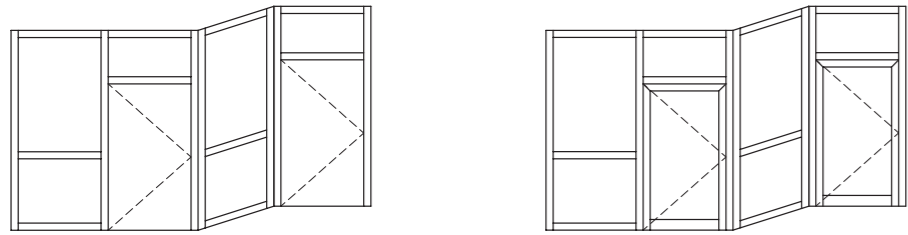
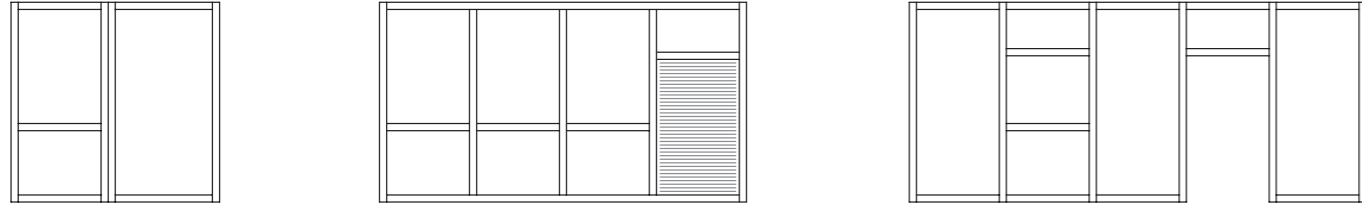

## PARTITION WALLING SYSTEMS MB-80 OFFICE

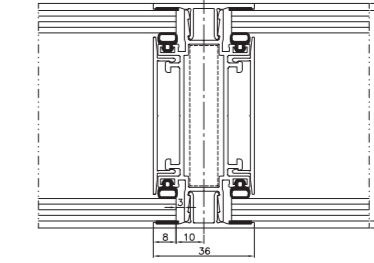

80 mm wall - vertical view

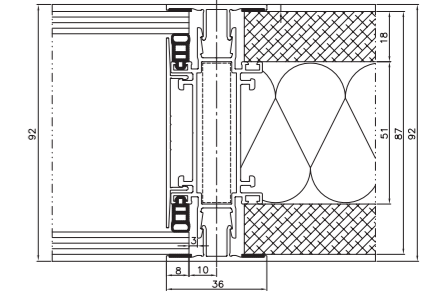

92 mm wall - vertical view

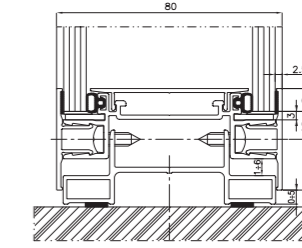

Lower crossbar - view

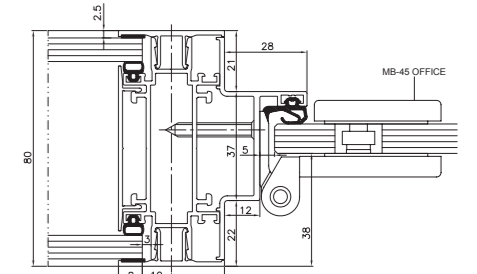

Door - horizontal view

## FEATURES AND BENEFITS

- different types of infill: panes 4-14 mm thick, furniture boards 16-18 mm thick, gypsum plasterboards
- depth & construction of the basic profiles enables installation of intra-pane louvers
- can be combined with a standard, 75 mm-thick gypsum plasterboards
- excellent sound insulation in office spaces – noise reduction of 50 dB depending on the type of infill used
- possibility to fabricate 80 mm & 92 mm walls
- custom division of space, angle of refraction within the range 90°÷180°
- simple fabrication & installation, direct on-site pre-fabrication in option
- cables inside the wall, installation of standard power sockets
- can be combined with MB-45 wall or MB-45 (centrally or flushed with the plane of the wall) and with MB-45S door (flushed with the plane of the wall and with non-protruding hinges), and MB-45 OFFICE (with centrally-installed leaf, flushed with the plane of the wall, plus non-protruding hinges)
- high rigidity of the profiles makes the construction fit to any interior space, for instance, a construction with 4 mm glass and 1.3 m post spacing can be up to 5.4 m high and up to 6.35 m if the posts are steel core-reinforced

**MB-45**  
**MB-45 OFFICE**



PARTITION WALLING  
SYSTEMS

**MB-45**  
**MB-45 OFFICE**

# MB-45 MB-45 OFFICE

## PARTITION WALLING SYSTEMS

Various types of infills and glass panes can be used: both single and insulating, with thicknesses ranging from 2-25 mm. The system comes equipped with dedicated 8, 10 and 12 mm large-size tempered glass

All-glass door leaves for hinged and swinging-type doors

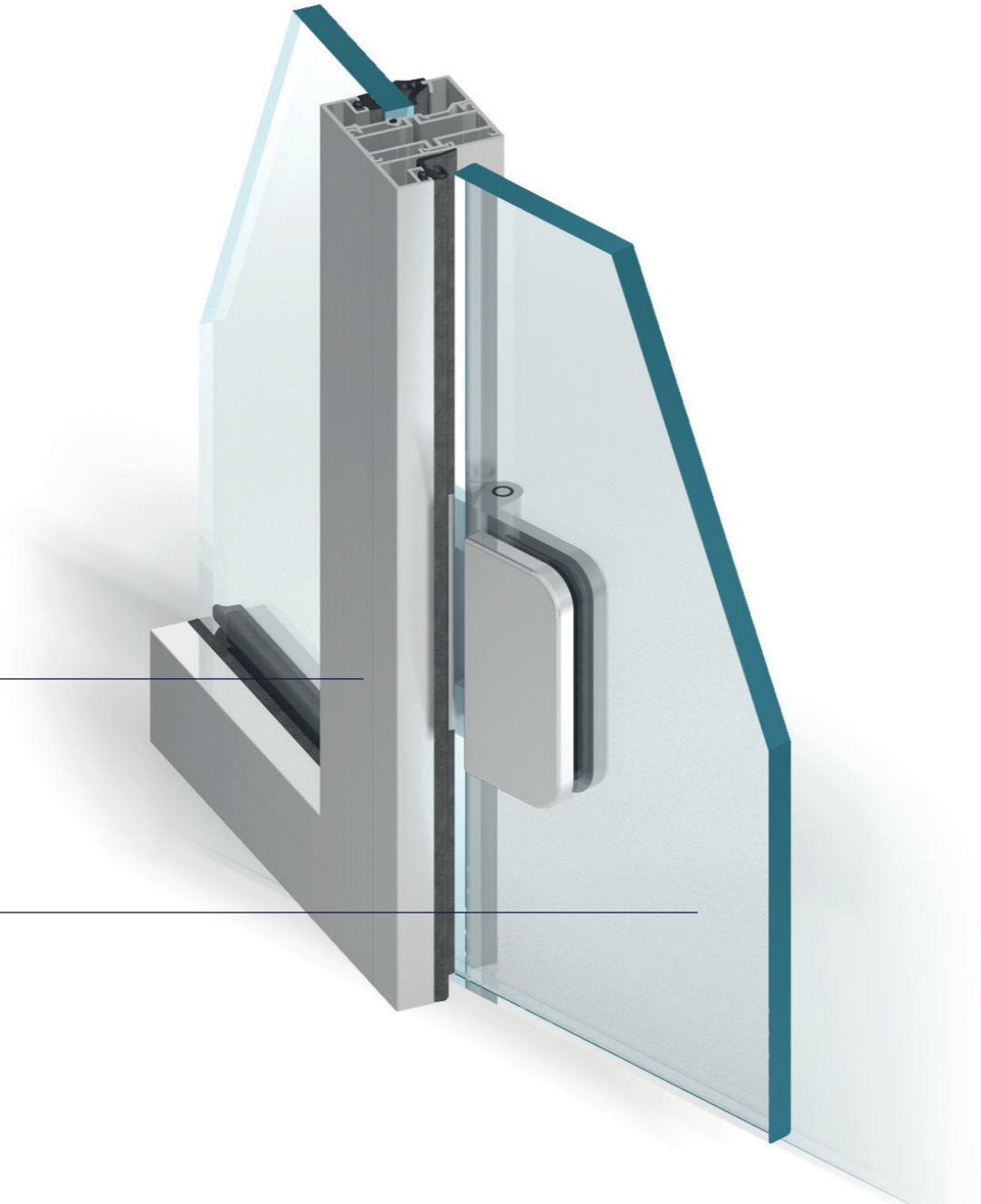

Due to its versatility and wide application possibilities, the **MB-45 & MB-45 OFFICE** systems are dedicated to the fabrication of lightweight, yet solid partition walls in conference rooms and office spaces with “clearly marked” door.

The **MB-45 OFFICE** fixed and door-equipped partitioning system is designed to fabricate internal partition walls whose distinguishing feature is their tempered glass pane used as a structural component. The elements of this system enable fabrication of fixed partition walls and all-glass door leaves for hinged and swinging-type doors.

**MB-45** is used to fabricate various types of partition walls, windows, doors, including manual & automatic sliding doors, swing doors, vestibules, and other spatial structures. **MB-45** can be used for special scenarios such as fabrication of smokes resistant partition walls & doors **MB-45D** (classes:  $S_{200}$ ,  $S_a$ ).

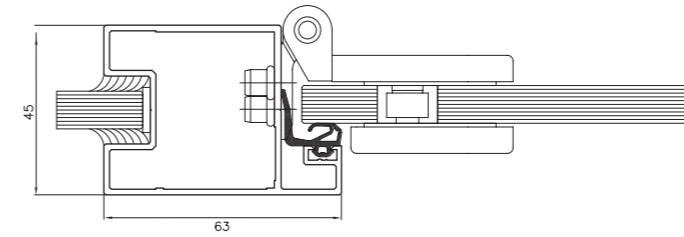
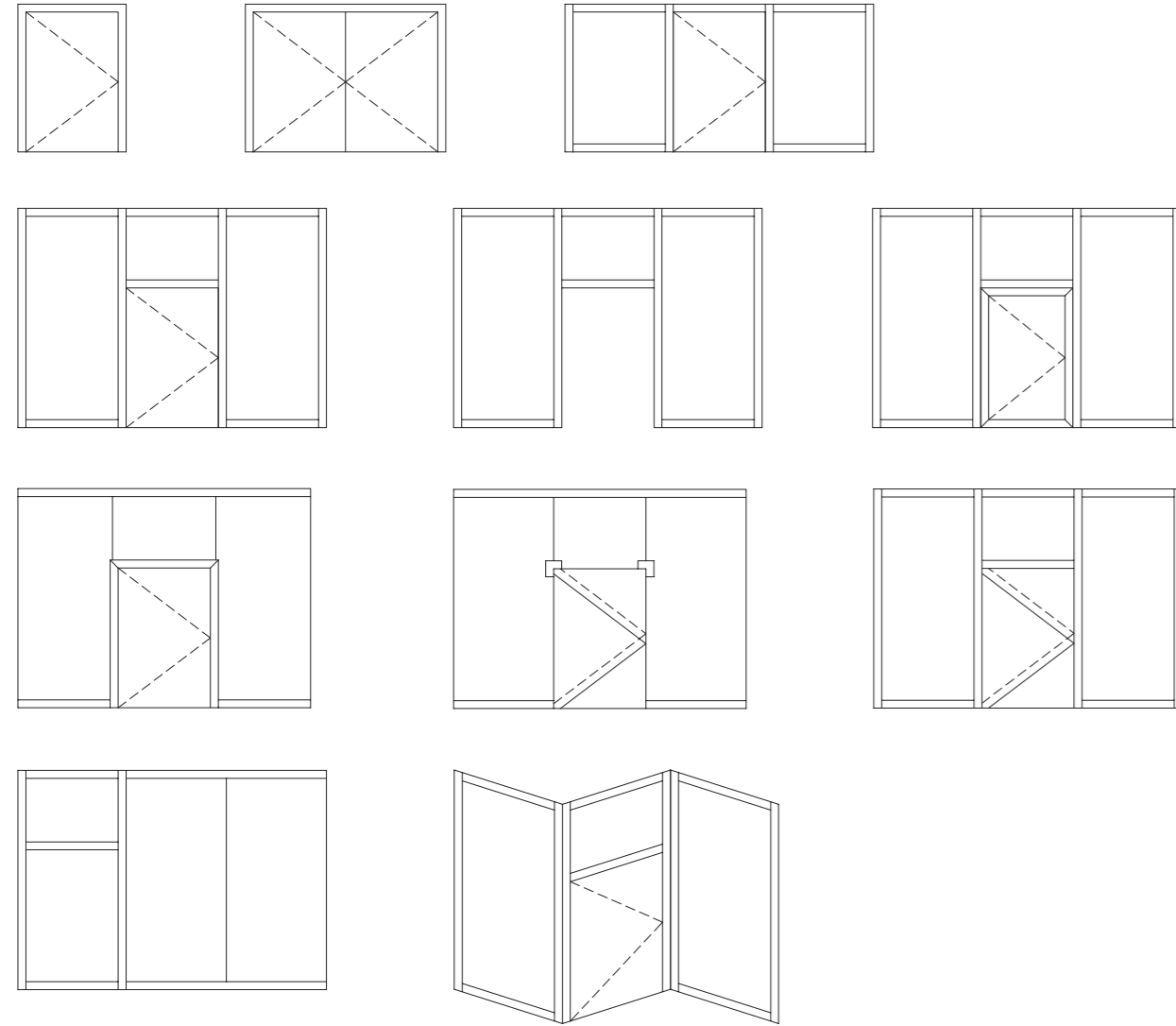

Door stud and upper crossbar – view

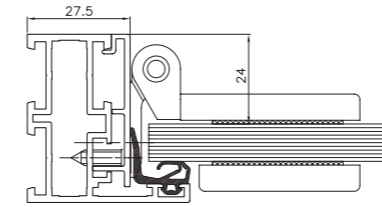

Door – side view

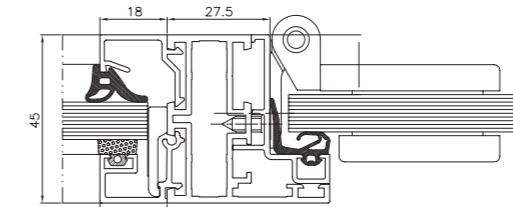

Door stud – section view

## FEATURES AND BENEFITS

- light and durable structure
- design depth 45 mm
- infill ranging from 2-25 mm (dedicated, 8, 10 and 12 mm tempered glass panes)
- various types of partition walls, windows, doors, including manual & automatic sliding doors, swing doors, vestibules, etc.
- smoke-resistant doors MB-45D (in  $S_{200}$  and  $S_a$  classes )
- continuously mounted glazing gaskets, no more cutting at the corners
- possibility of changing interior design
- adapted to use numerous companies' hardware products: Aluprof, WSS





**MB-78EI**



SYSTEM SILICONE JOINED  
FIRERATED GLAZED WALLS,  
CLASSES **EI30** & **EI60**

# MB-78EI

## PARTITION WALLING SYSTEMS

4 mm-thick joint.  
Infill made of fire stop intumescent material  
and non-flammable silicone

Fire resistance classes  
EI30 & EI60

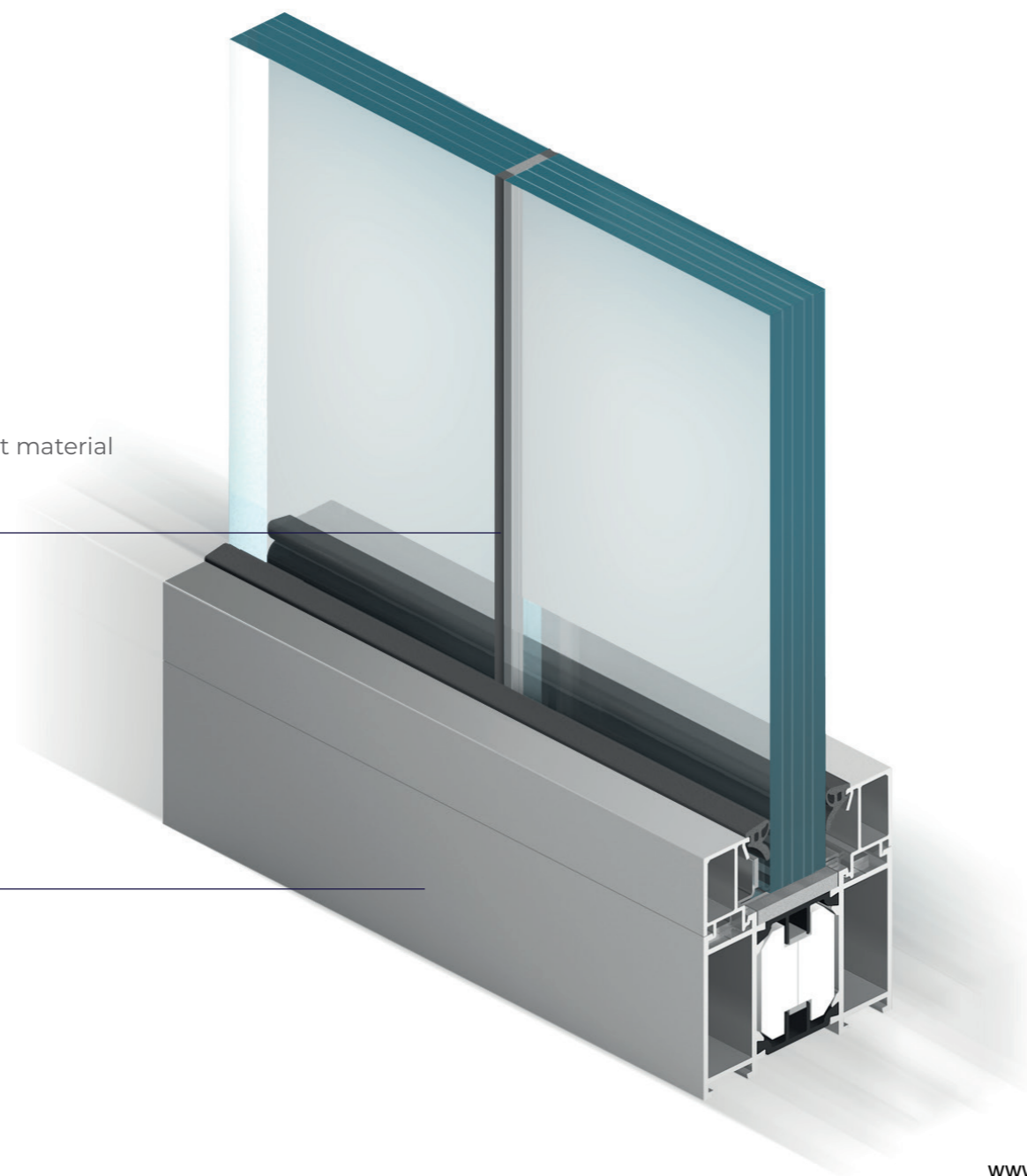

## SILICONE JOINED FIRE-RATED GLAZED WALLS **MB-78EI**

Aluprof offers **MB-78EI** system-based transparent fire-rated wall solution – “**Silicone joined fire-rated glazed walls**”. It enables fabrication of internal partitions walls without the visible vertical wall profiles that separate the individual modules of the wall, while preserving its full fire resistance. The joint between the glass panes is only 4 mm, and is filled with firestop, intumescent material and with non-inflammable silicone. The silicone is available in three colours (black, grey or white).

Partition walls can thus have a height of more than 3.6 m with modules' width up to 1.8 m. Fire tests performed by the Poland's Building Research Institute (ITB) on these partition walls included the so-called “free-edge model”, so there is no limit on the maximum length of this type of walls.

**MB-78EI Silicone joined glazed wall system** brings you virtually unlimited design and construction possibilities, offering very large internal partition walling products. Thanks to the transparent modules, all the constructions fabricated using this system make your interiors optically bigger. The system also provides security by allowing the arrangement of the building's fire zones and this ensuring appropriate conditions for the evacuation of building occupants.

# MB-78EI

## PARTITION WALLING SYSTEMS

Transparent modules  
up to 3.6 m high

Fire resistance classes  
EI30 & EI60

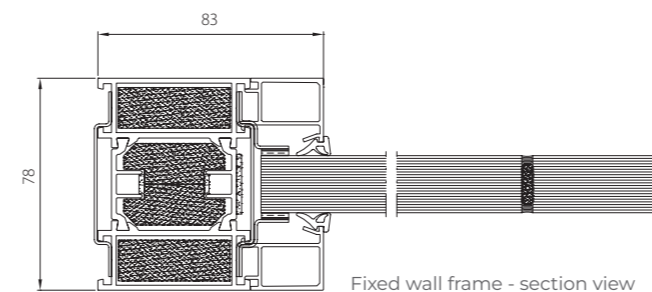
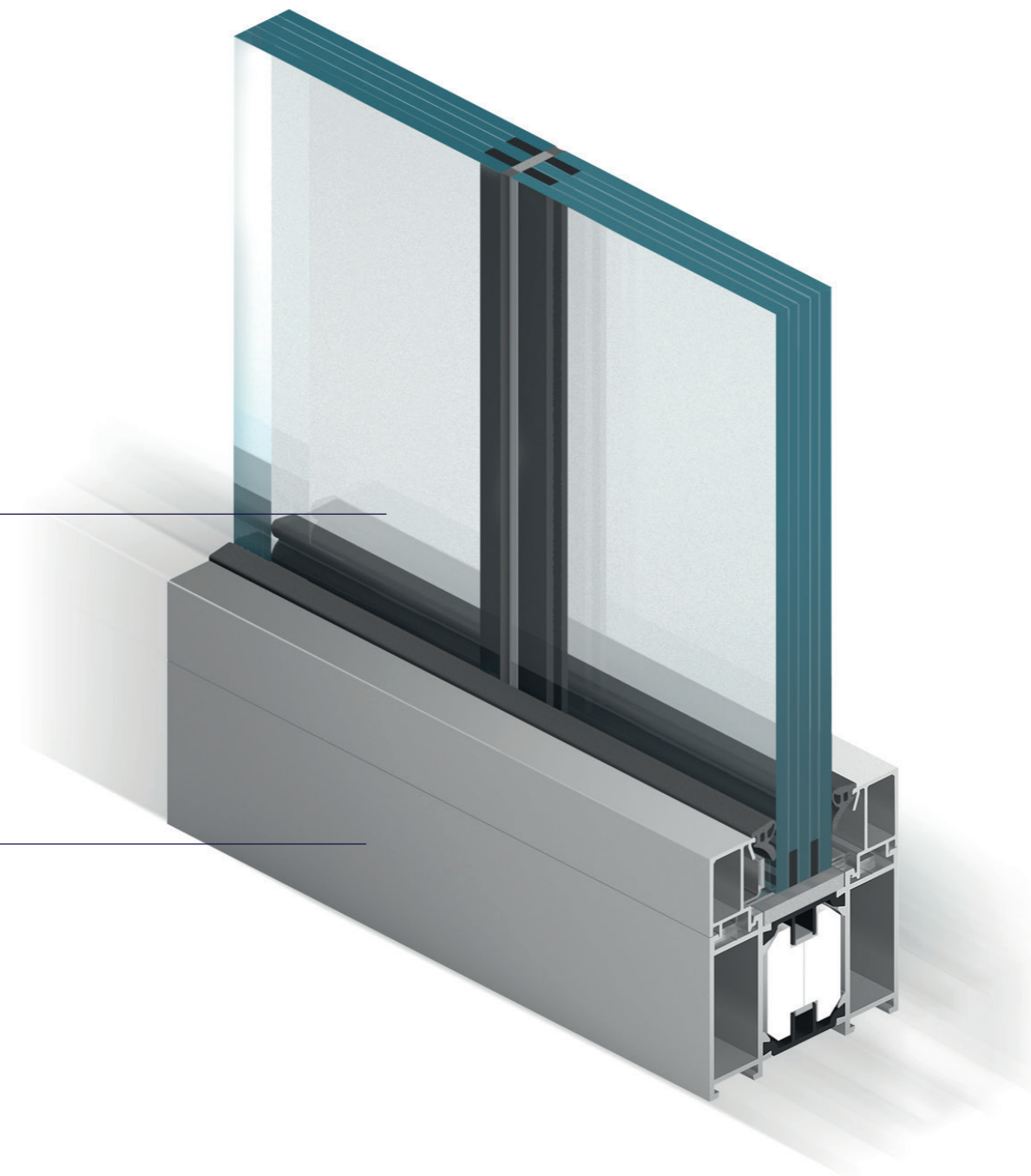

Fixed wall frame - section view

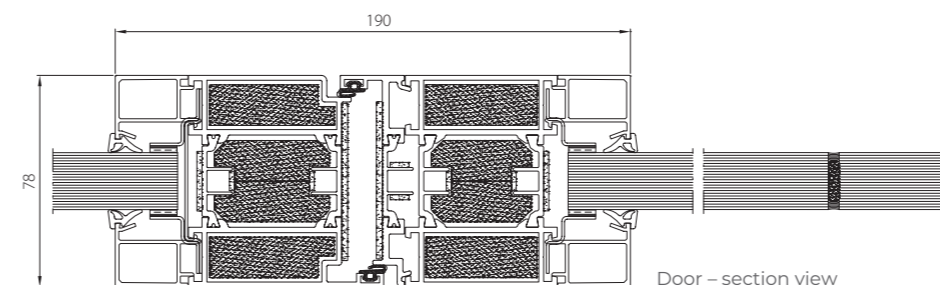

Door - section view

## FEATURES AND BENEFITS

- Aluprof's solution has been designed and then tested at the ITB in two fire-rating classes: EI30 & EI60
- joint width between the modules is only 4 mm
- max. width of glass modules: 1.5 m (H max 3.6 m) and 1.8 m (H max 3.0 mm)
- unlimited width of a single wall

## SILICONE JOINED FIRE-RATED GLAZED WALLS MB-78EI



**MB-78EI**



SYSTEMSILICONE JOINED  
FIRERATED GLAZED WALLS,  
CLASSES **EI30** & **EI60**

# MB-78EI

## PARTITION WALLING SYSTEMS

The office is optically bigger thanks to the concealed wall mounting - modules of a width up to 1.8 m

Available for fire resistance classes  
EI30 & EI60

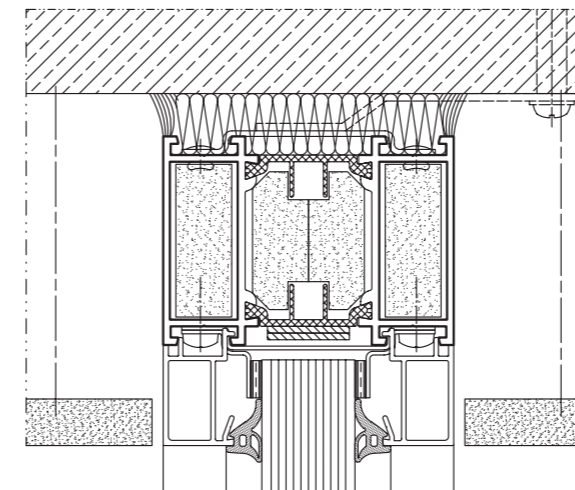
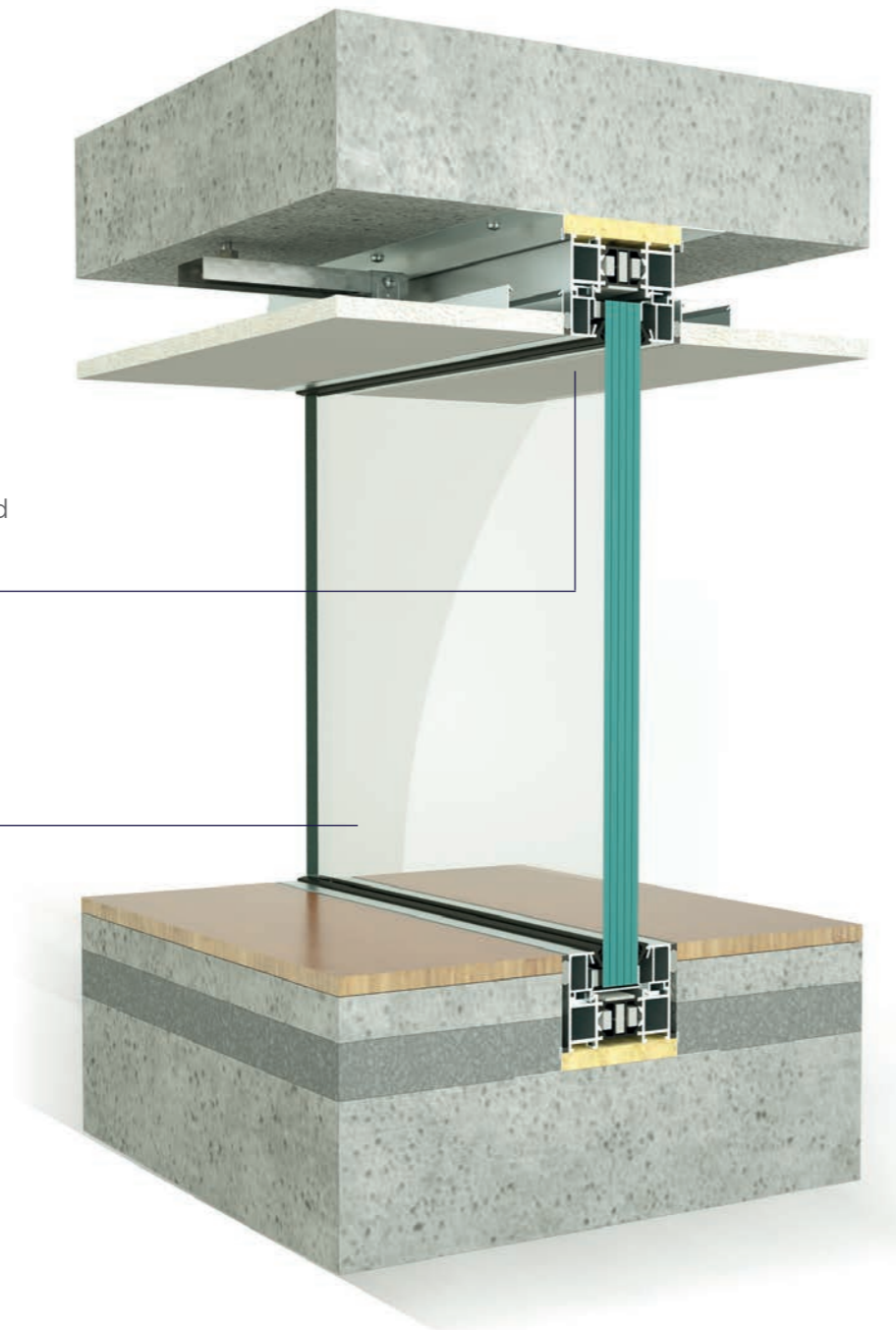

Silicone joined glazed wall – top

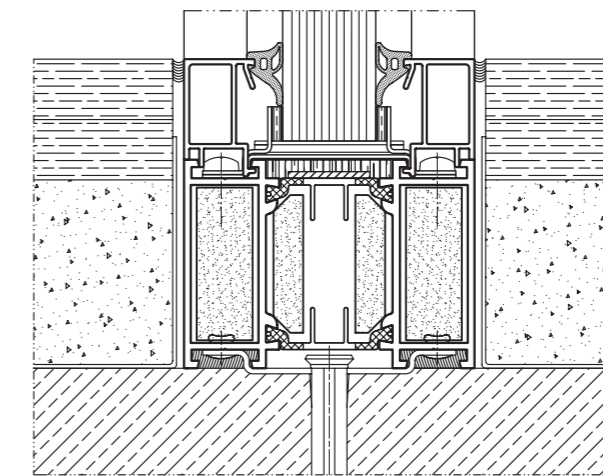

Silicone joined glazed wall – bottom

## FEATURES AND BENEFITS

- available in two fire protection classes: EI30 & EI60
- joint width between the modules is only 4 mm
- max. width of glass modules: 1.5 m (H max 3.6 m) and 1.8 m (H max 3.0 m)
- unlimited width of a single wall

## SILICONE JOINED FIRE-RATED GLAZED WALLS **MB-78EI**



## MB-78EI



SYSTEM SILICONE JOINED  
FIRERATED GLAZED WALLS,  
CLASSES **EI30** & **EI60**