



LET'S BUILD A BETTER FUTURE

Door and window systems **MB-60**

The MB-60 is a stable, universal and complete window and door system for any application requiring enhanced thermal performance that reflect different needs of the various market segments. Its wide selection of compatible components enables to construct various elements from basic thermally insulated windows and doors to pivot and concealed sash windows, industrial type windows with the steel like lookout and security doors. Majority of system varieties are available in both standard and HI version with increased thermal insulation properties.



great number of solutions' options

MB-60
MB-60 HI

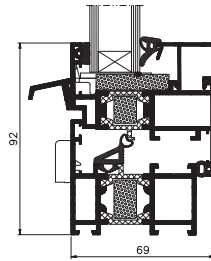

window – cross-section MB-60HI

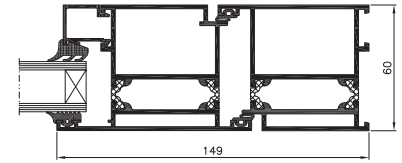

door – cross-section MB-60

Profiles in the basic MB-60 system have a 3-chamber structure and an omegatype thermal barrier. The system is also available in a version with improved thermal insulating power MB-60HI, obtained due to the use of special insulation inserts inside sections and under panes.

MB-60US
MB-60US HI

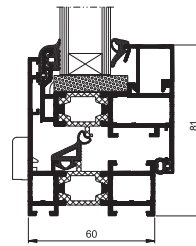
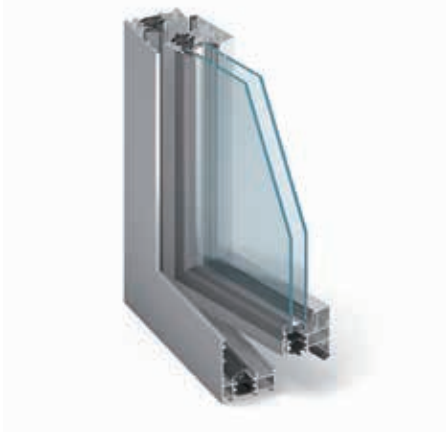

opening window – cross-section

The invisible sash system variety enables to accomplish an effect of indifferent look of series of neighboring combination of fixed and opening windows from the outside of the building. It is presented in regular and enhanced thermal performance varieties.

MB-60 PIVOT

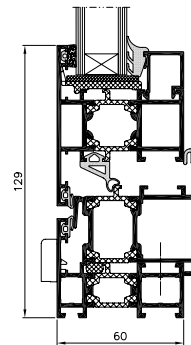

pivot window – cross-section

The pivot variety is available for both vertical pivot and horizontal pivot applications ensuring flexibility. Its hardware enables for window to open a full 180 degrees. The key competitive advantages it offers include large size and weight limitations.

MB-60 INDUSTRIAL
MB-60 INDUSTRIAL HI

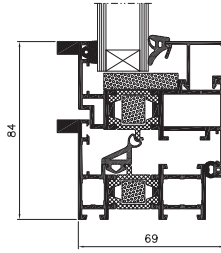

opening window – cross-section

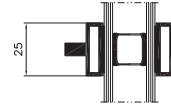

glued-on mullion – cross-section

The characteristic feature of windows in Industrial version is that the profiles are enriched with additional decorative elements referring in their appearance to steel windows in buildings which are subject to conservatory protection. Their use makes the modernised building gain the incomparably higher protection against heat loss through windows.

MB-60E
MB-60E HI

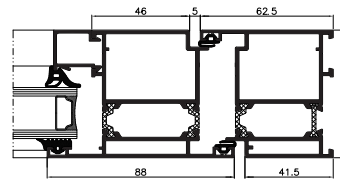

door – cross-section

The extremely cost efficient system for making thermally insulated doors and sets of windows and doors. It offers combination of good performance and limited production costs related to shorter time and high ease to manufacture.

MB-60EF
MB-60EF HI

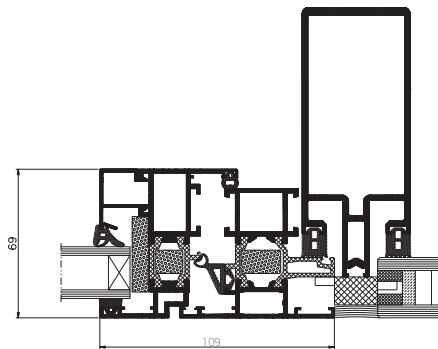
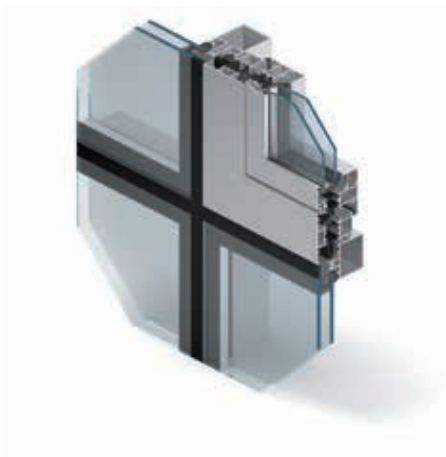

active window in a curtain wall – cross-section

The system variety features windows integrated with the MB-SR50 EFEKT curtain wall partitions, therefore enables for specific visual effect – on the "all-glass" external surface of the curtain wall there comes a clear outline of an aluminum window frame. External surfaces of window profiles and glass panels are aligned. It is presented in regular and enhanced thermal performance varieties.

FEATURES AND AESTHETICS

- windows available as fixed, tilt and turn, tilt and slide and pivot
- hidden vent option
- 1 or 2 leaf doors open in or open out
- large size door constructions available
- glazing up to 50 mm
- burglar resistant secure windows and doors options
- dual color options
- lower cost door option
- numerous finish options
- multi-point locking
- eurogroove that broadens the choice of hardware available
- suites with other Aluprof's MB systems allowing total design flexibility and project solutions
- compliance with CE marking requirements

TECHNICAL SPECIFICATION	MB-60 MB-60 HI	MB-60US MB-60US HI	MB-PIVOT	MB-60E MB-60E HI	MB-60EF MB-60EF HI
Frame depth (door / window)	60 mm / 60 mm	60 mm			
Casement depth (door / window)	60 mm / 69 mm	69 mm		60 mm	69 mm
Glazing rang (fixed window and door / opening window)	5 – 44 mm / 14 – 52 mm	4 – 35 mm / 8 – 44 mm	5 – 41 mm / 14 – 50 mm	5 – 41 mm	—
MIN VISIBLE WIDTH T PROFILE					
Frame (door / window)	51 mm / 47 mm	75 mm	47 mm	41.5 mm	72 mm
Casement (door / window)	72 mm / 29 mm	34.6 mm	76 mm	67 mm	72 mm
SIZE LIMITATIONS					
Max. size of window (H×L)	H to 2400 mm L to 1250 mm	H to 1900 mm L to 1100 mm	H to 2000 mm L to 2400 mm	—	H to 2400 mm L to 1250 mm
Max. size of door (H×L)	H to 2400 mm L to 1200 mm	—	—	H to 2300 mm L to 1300 mm	—
Max. weight (door / window)	120 kg / 130 kg	130 kg	180 kg	120 kg	130 kg
TYPES OF CONSTRUCTION					
Solutions	tilt windows, turn windows, tilt turn windows, tilt sliding windows and doors, doors open in and open out	fixed windows, tilt windows, turn windows, tilt turn windows	pivot windows	doors and window and door sets	windows in curtain walls

PERFORMANCE	MB-60 MB-60 HI	MB-60US MB-60US HI	MB-PIVOT	MB-60E MB-60E HI	MB-60EF MB-60EF HI
Air permeability	class 4			class 3	class 4
Windload resistance	class C5, EN 12211; EN 12210		class C2, EN 12211; EN 12210	class C1, EN 12211; EN 12210	class C4, EN 12211; EN 12210
Impact resistance	class 3	—	—	class 3	—
Water tightness	class E900, EN 1027; EN 12208			class E1200, EN 1027; EN 12208	
Thermal insulation	U _f from 1,4 W/(m ² K)	U _f from 1,7 W/(m ² K)	—	U _f from 2,8 W/(m ² K)	—